

RS-232 to RS-485 interface converter (RS-232 to RS-485 and backwards)

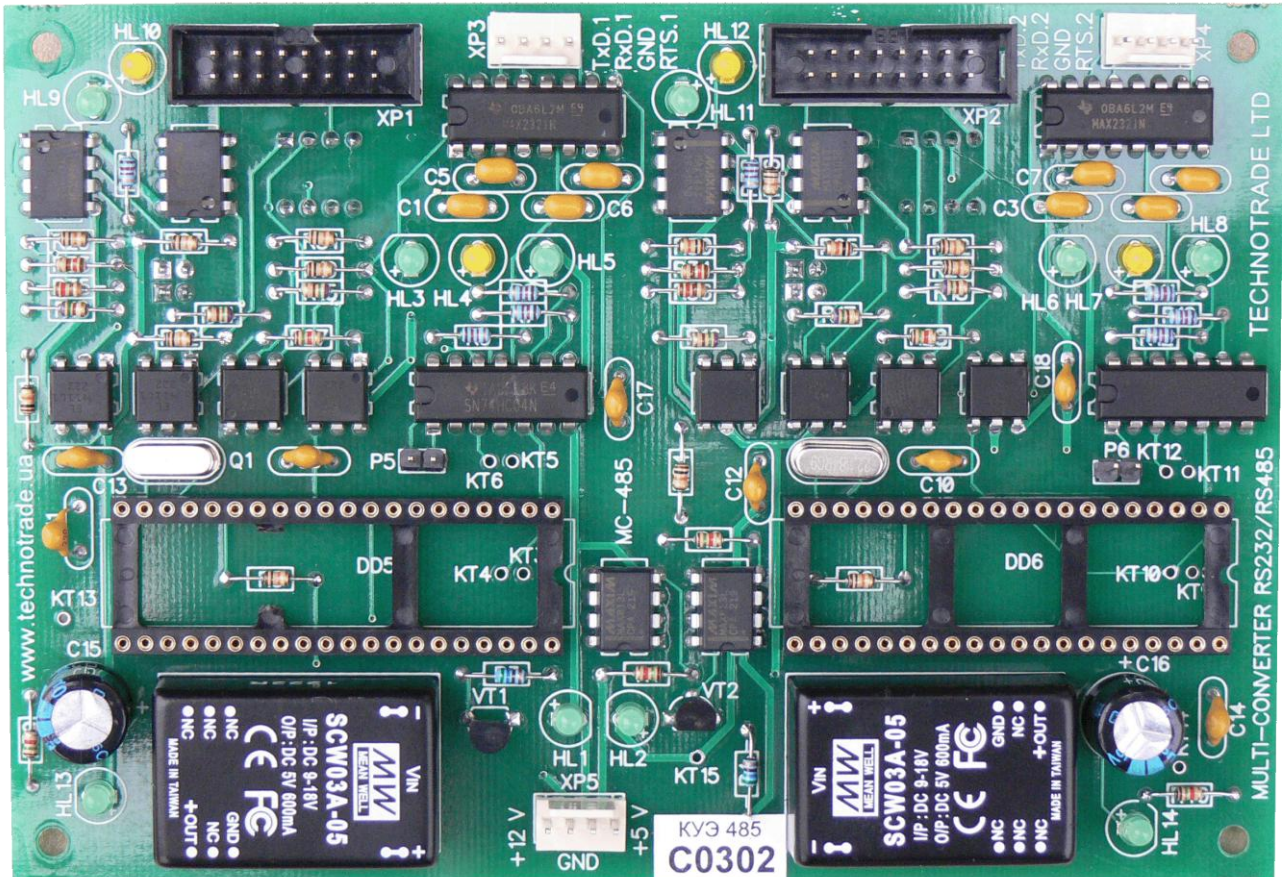

TECHNICAL GUIDE

Review date: 06 Jan 2013

Revision number: 1.02

PCB board revision: 1.01

TECHNOTRADE LTD

CONTENT

REVISION HISTORY	3
PURPOSE OF THE DOCUMENT	4
APPOINTMENT	5
TECHNICAL SPECIFICATIONS	6
PCB BOARD CONNECTORS OVERVIEW	7
OPERATION	9
PCB MOUNTING BOARD	10
CABLINGS.....	12

REVISION HISTORY

REV	DATE	BY	SECTION	DESCRIPTION
1.02	06.01.2013	EV	All	All sections reviewed
1.01	09.06.2010	EV	All	First release

PURPOSE OF THE DOCUMENT

This Technical Guide is intended for studying of RS-232 to RS-485 interface converter. It contains basic information regarding its board interfaces and connectors, configuration and adjustments, connection to fuel dispensers and external control systems (POS systems, cash registers, OPT terminals, etc), cabling. Information regarding connection to specific models of fuel dispensers and correspondent configuration of the RS-232 to RS-485 interface converter can be received upon request to TECHNOTRADE LTD company.

Due to a reason that RS-232 to RS-485 interface converter is constantly being developed in direction of improvements of its possibilities, changes are possible in final version, which are not described in given Technical Guide.

During the system development process given Technical Guide will be also expanded and updated and new chapters will be added. Latest version of this Technical Guide can be downloaded from the RS-232 to RS-485 interface converter web-page: http://www.technotrade.ua/rs232_to_rs485_converter.html.

TECHNOTRADE LTD hereby permits reproduction of this document as may be required by any of the customers or OEMs wishing to use it.

This document has been carefully prepared and is believed to be accurate. However TECHNOTRADE LTD, its employees and its agents do not assume responsibility for its use either directly or indirectly. TECHNOTRADE LTD shall not be liable for technical or editorial errors or omissions which may appear in this document. TECHNOTRADE LTD reserves a right to make changes to this document at any time without notice. Prospective users of this document should contact TECHNOTRADE LTD at the time they wish to use RS-232 to RS-485 interface converter together with their products to become aware of any updates that may apply.

All technical questions regarding the RS-232 to RS-485 interface converter are welcome to be asked on support mailbox: support_1a@technotrade.ua. Our support team will be glad to help you.

In case if you find any mistakes, omissions in this document or have any suggestions on improvements to this document, please feel free to e-mail them our support mailbox: support_1a@technotrade.ua. We will be grateful to you for this valuable information.

APPOINTMENT

RS-232 to RS-485 interface converter is intended for conversion of signals from RS-232 interface to signals of RS-485 interface and backwards. Converter contains 2 separate independent conversion channels.

TECHNICAL SPECIFICATIONS

Specification

Voltage	+12 V DC, +5 V DC
Current consumption	250 mA max
Temperature range	0°C ÷ +40°C
Weight	120 g
Dimensions	145 x 100 x 20 mm

Communication ports

RS-232 port	RS-232 (can be with RTS control)
RS-485 port	Half-duplex (2-wire) or full-duplex (4-wire)

Technical characteristics

Channels	Converter contains 2 separate independent channels
Galvanic isolation	Receiver and transmitter are galvanically isolated
RTS control	RS-232 port can receive RTS control, for cases when it does not receive RTS control a RTS generating chip should be installed

PCB BOARD CONNECTORS OVERVIEW

Top view

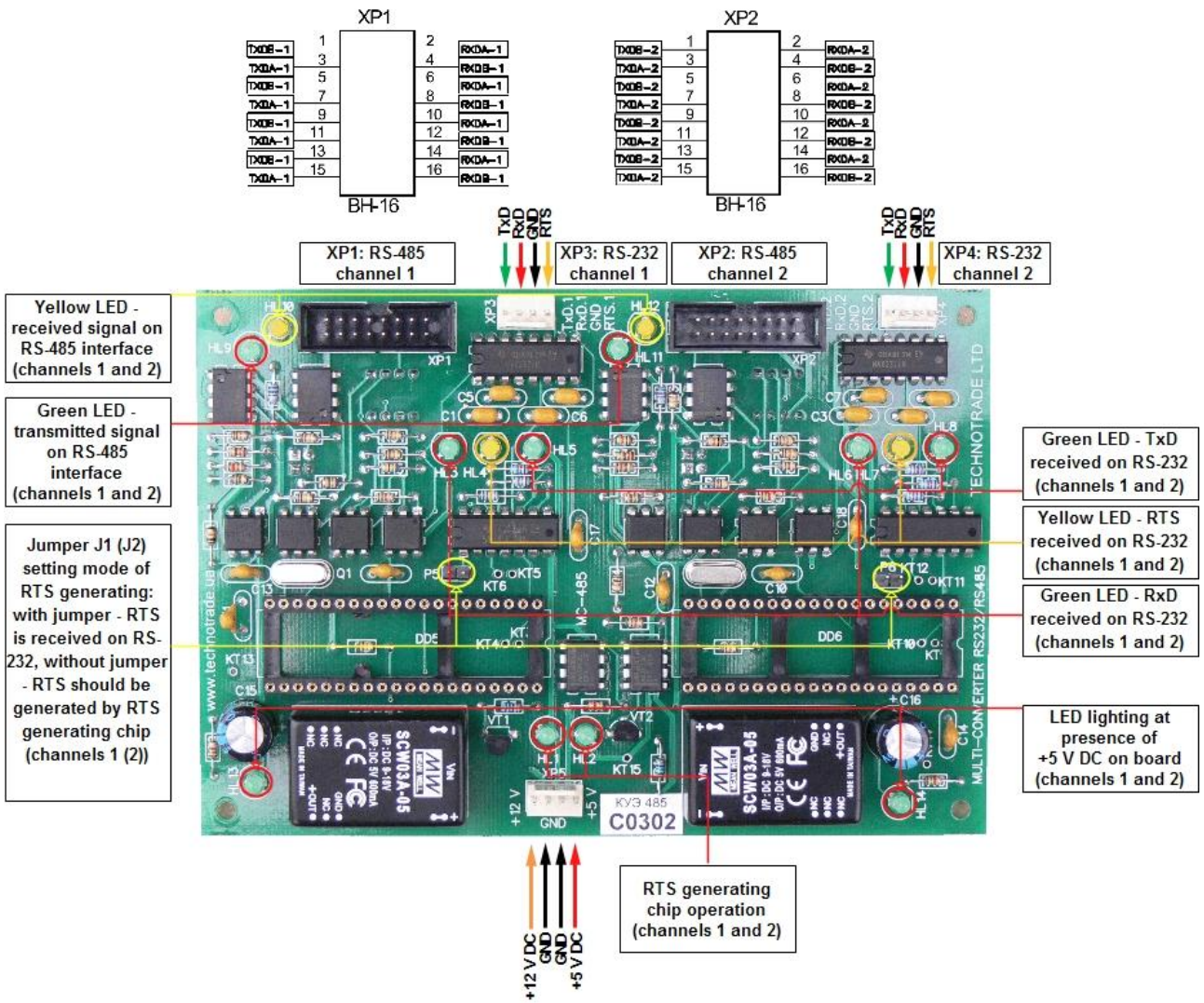

Back view

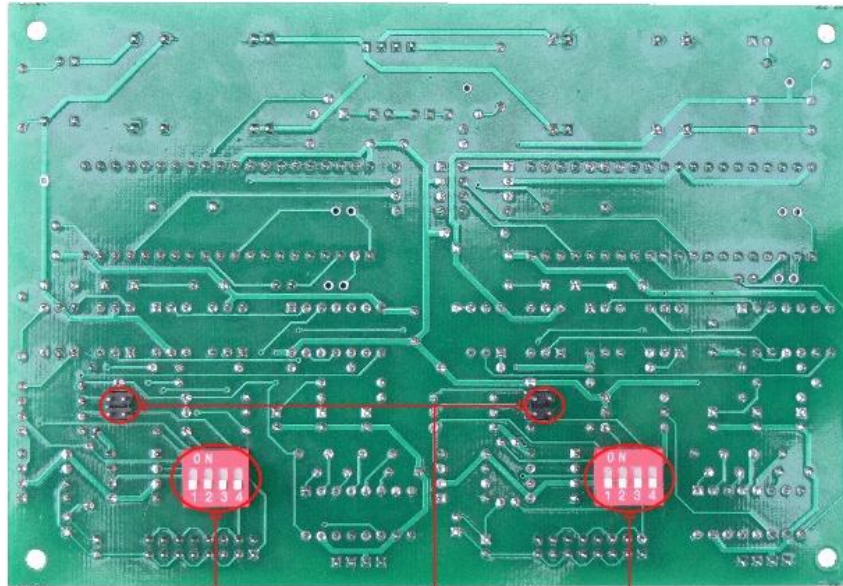

Switch S2 -
configuration of
channel 2

Jumpers for
connecting
additional 120 Ohm
resistor loading to
each of lines of 4-
wire RS-485 interface
(for long lines
communication)

Switch S1 -
configuration of
channel 1

OPERATION

Signals of RS-232 interface enter the MAX232 chip, where are converted into signals of TTL logics, and after conversion go through optocouplers H11L1, that serve for galvanic isolation of transmitter and receiver, enter the TTL input of MAX485 chip, from the output of which signals of RS-485 interface are received. Analogous behavior takes places in contrary direction of signals.

The board of the Converter has 2 separate channels, the only thing which unites them is source voltage +5 V, which feeds interface RS-232. Voltage +5 V for circuits of RS-485 interface of the channels is taken from separate DC-DC converters with galvanical isolation for the channels.

Depending on the state of switches S_n (where $n=1,2$ – number of channel) output of RS-485 interface can be adjusted for operation in half-duplex or full-duplex modes (2-wire or 4-wire schemes of connection accordingly). When switches $S_{n:1}$, $S_{n:3}$, $S_{n:4}$ (where $n=1,2$ – number of channel) are in position “OFF” – the Converter works in full-duplex (4-wire) mode of RS-485 interface, in position “ON” - the Converter works in half-duplex (2-wire) mode of RS-485 interface. Switch $S_{n:2}$ (where $n=1,2$ – number of channel) is intended for switching on (position “OFF”) or turning off (position “ON”) of echo mode in half-duplex (2-wire) mode of RS-485 interface (repeating of all signals, received on input).

Half-duplex (2-wire) mode of RS-485 interface requires presence of RTS (Request To Send) signal on the input of RS-232 interface for synchronization of transmit/receive. In case if RTS signal is impossible to receive from the source of signal of RS-232 interface, then it is possible to generate it with a help of RTS generating chips of each channel, which are installed only in case of such necessity. If input of RS-232 interface contains RTS signals and RTS generating chips are not installed then it is necessary to place a jumper J_n (where $n=1,2$ – number of channel) for the required channel, in contrary case the jumper should be removed.

PCB MOUNTING BOARD

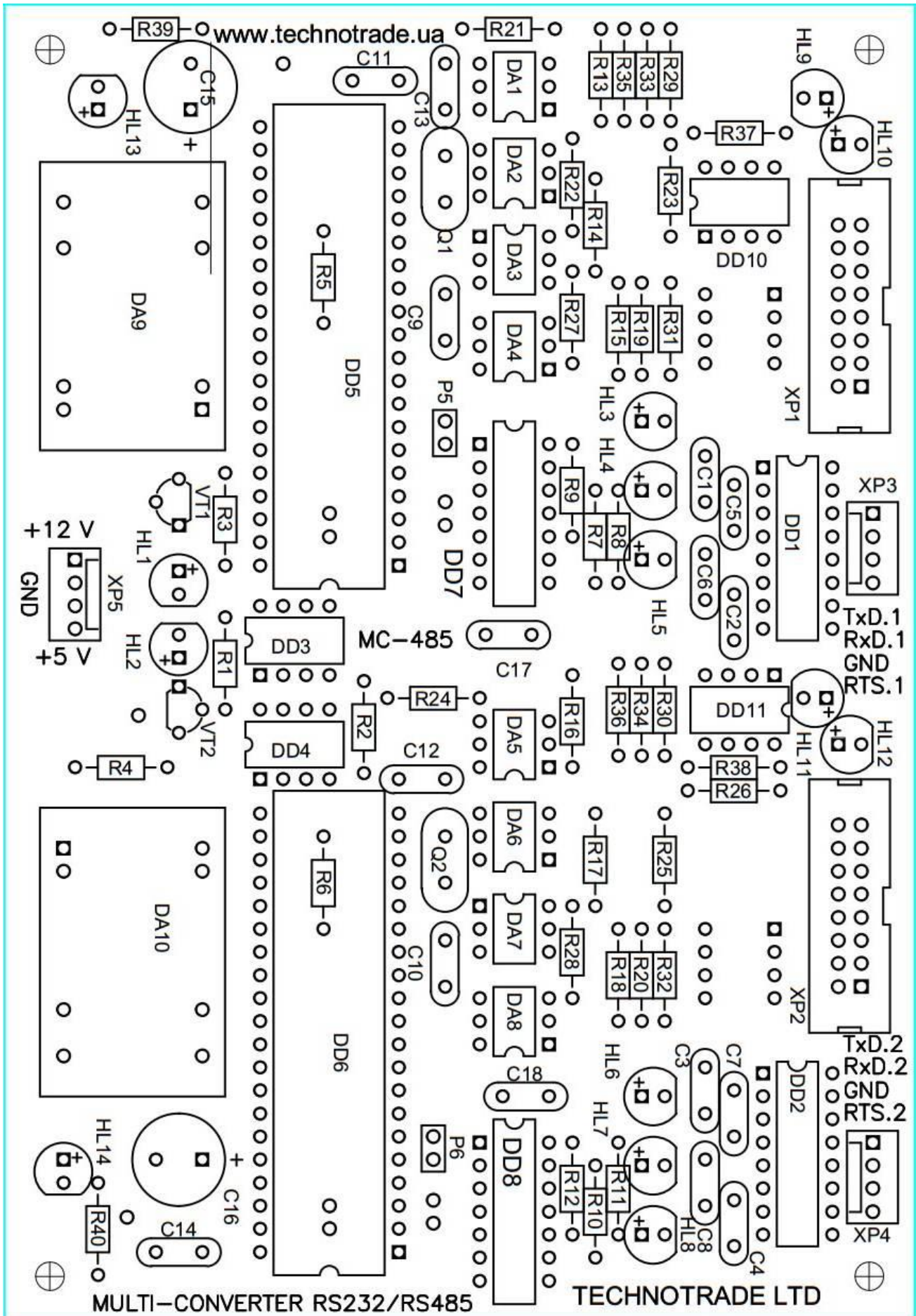

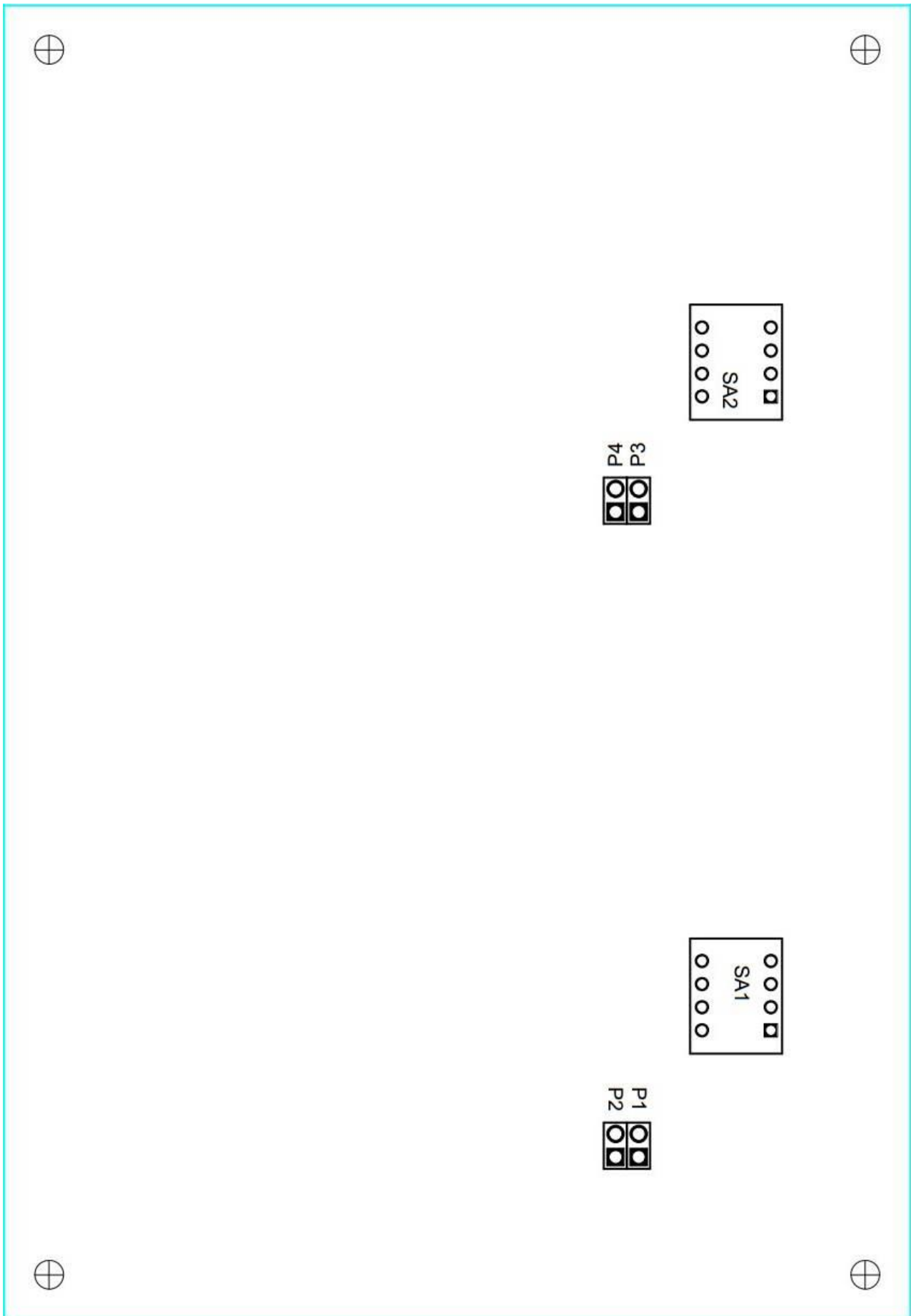

CABLINGS

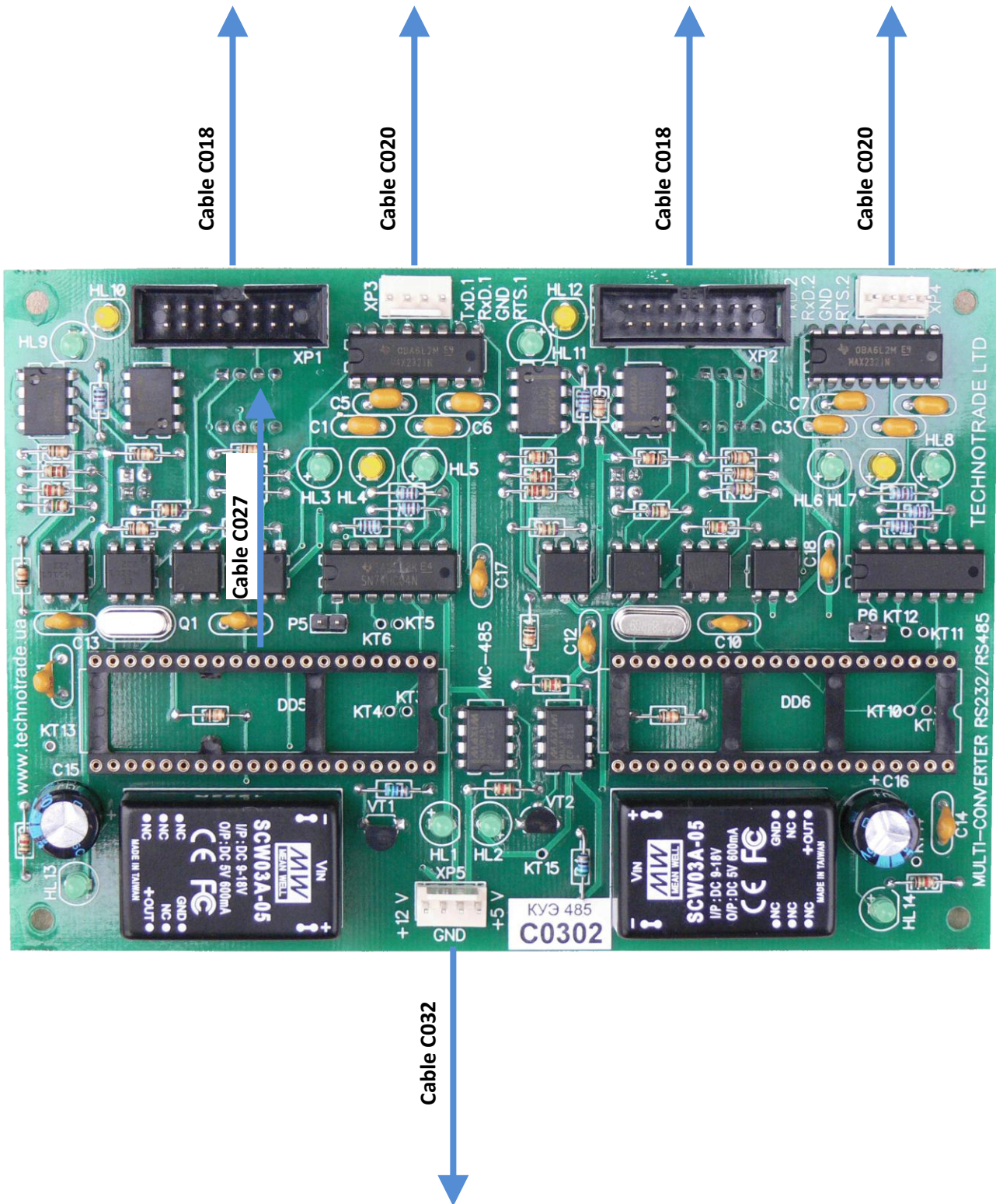

CABLE C018

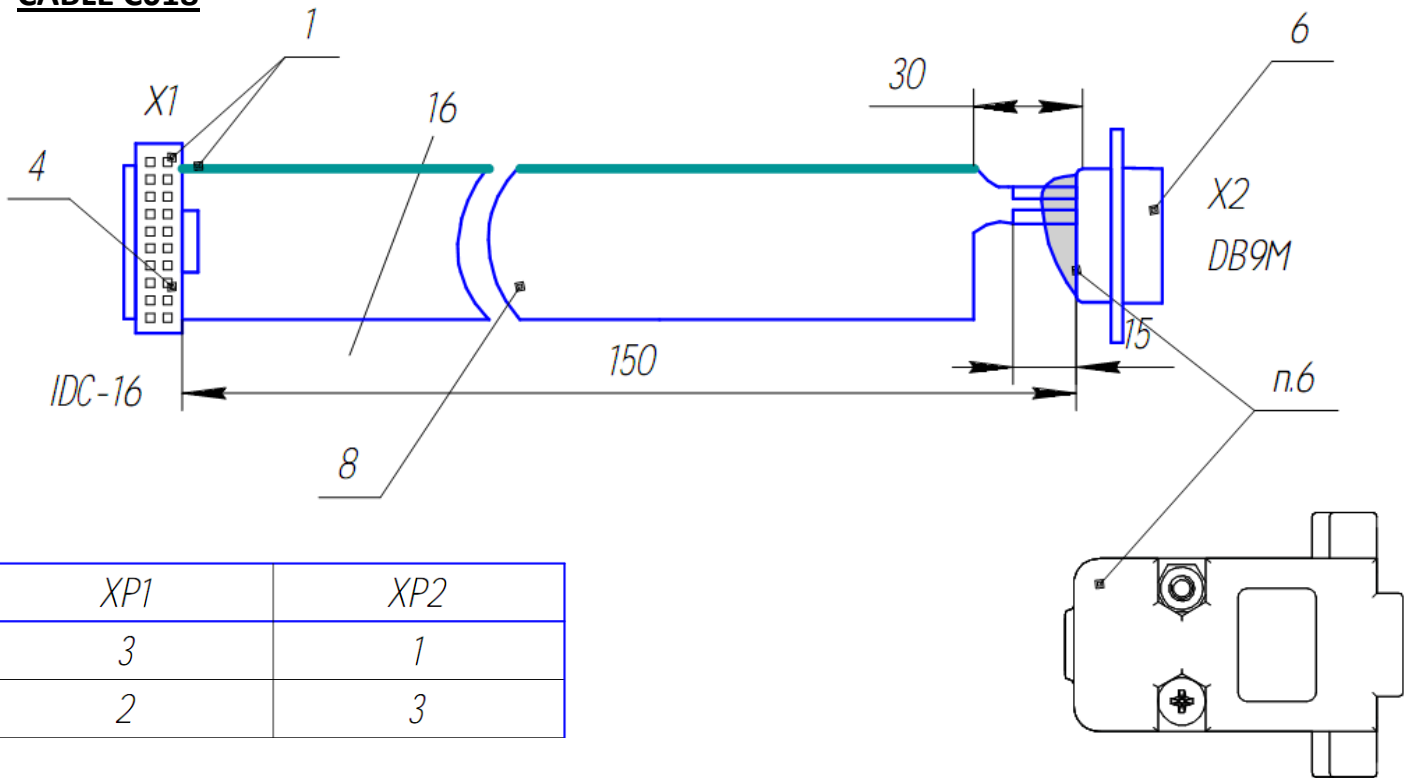

XP1	XP2
3	1
2	3

CABLE C020

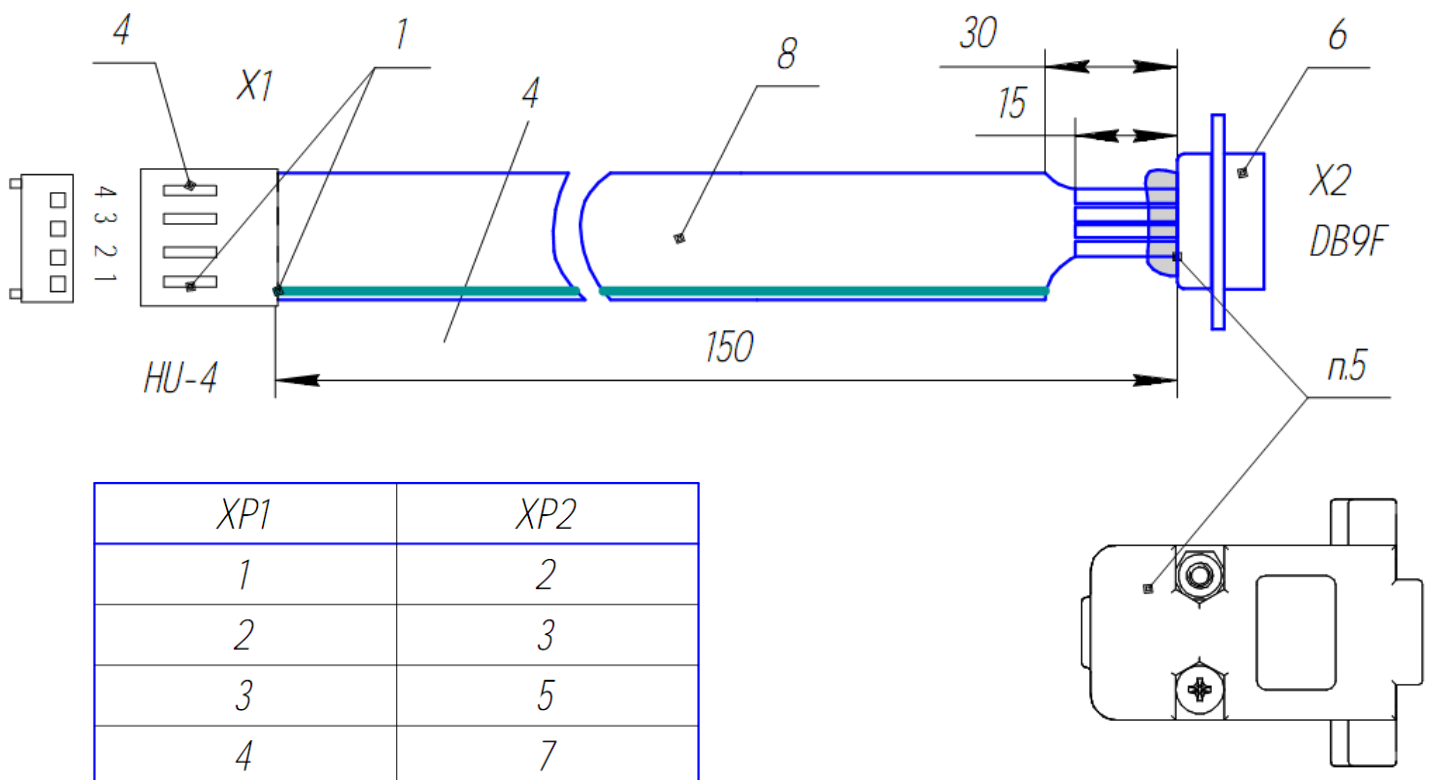

XP1	XP2
1	2
2	3
3	5
4	7

CABLE C032

